

Tandem 600V HYPERFAST RECTIFIER

MAJOR PRODUCTS CHARACTERISTICS

I_{F(AV)}	5 A
V_{RRM}	600 V (in series)
T_{j (max)}	150 °C
V_{F (max)}	2.6 V
I_{RM (typ.)}	3.6 A

FEATURES AND BENEFITS

- ESPECIALLY SUITED AS BOOST DIODE IN CONTINUOUS MODE POWER FACTOR CORRECTORS AND HARD SWITCHING CONDITIONS
- DESIGNED FOR HIGH di_F/dt OPERATION. HYPERFAST RECOVERY CURRENT TO COMPETE WITH SiC DEVICES. ALLOWS DOWNSIZING OF MOSFET AND HEATSINKS
- INTERNAL CERAMIC INSULATED DEVICES WITH EQUAL THERMAL CONDITIONS FOR BOTH 300V DIODES
- INSULATION (2500V_{RMS}) ALLOWS PLACEMENT ON SAME HEATSINK AS MOSFET FLEXIBLE HEATSINKING ON COMMON OR SEPARATE HEATSINK.
- MATCHED DIODES FOR TYPICAL PFC APPLICATION WITHOUT NEED FOR VOLTAGE BALANCE NETWORK
- Package Capacitance: C=7pF

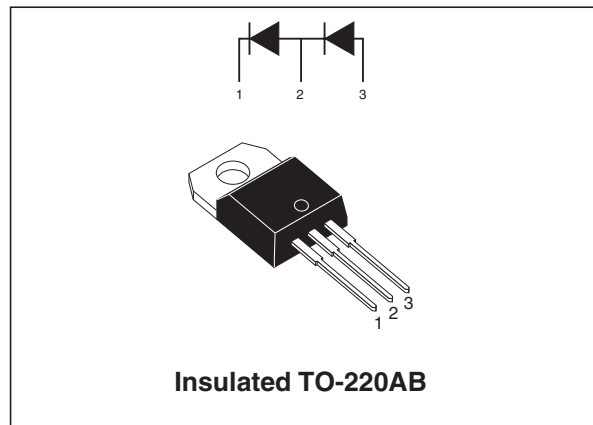

DESCRIPTION

The TURBOSWITCH “H” is an ultra high performance diode composed of two 300V dice in series. TURBOSWITCH “H” family drastically cuts losses in the associated MOSFET when run at high di_F/dt .

ABSOLUTE RATINGS (limiting values, for both diodes)

Symbol	Parameter		Value	Unit
V _{RRM}	Repetitive peak reverse voltage		600	V
I _{F(RMS)}	RMS forward current		14	A
I _{FSM}	Surge non repetitive forward current	tp = 10 ms sinusoidal	60	A
T _{stg}	Storage temperature range		-65 +150	°C
T _j	Maximum operating junction temperature		+ 150	°C

THERMAL AND POWER DATA

Symbol	Parameter	Test conditions	Value	Unit
$R_{th(j-c)}$	Junction to case thermal resistance	Total	3.0	°C/W
P	Conduction power dissipation for both diodes	$I_{F(AV)} = 5\text{ A}$ $\delta = 0.5$ $T_c = 100^\circ\text{C}$	17	W

STATIC ELECTRICAL CHARACTERISTICS (for both diodes)

Symbol	Parameter	Tests Conditions	Min.	Typ.	Max.	Unit
I_R^*	Reverse leakage current	$V_R = V_{RRM}$	$T_j = 25^\circ\text{C}$		6	μA
			$T_j = 125^\circ\text{C}$		8	
V_F^{**}	Forward voltage drop	$I_F = 5\text{ A}$	$T_j = 25^\circ\text{C}$		3.6	V
			$T_j = 125^\circ\text{C}$		2.1	

Pulse test : * $t_p = 100\text{ ms}$, $\delta < 2\%$

** $t_p = 380\text{ }\mu\text{s}$, $\delta < 2\%$

To evaluate the maximum conduction losses use the following equation :

$$P = 1.8 \times I_{F(AV)} + 0.16 I_{F(RMS)}^2$$

DYNAMIC CHARACTERISTICS (for both diodes)

Symbol	Parameter	Tests Conditions	Min.	Typ.	Max.	Unit	
t_{rr}	Reverse recovery time	$I_F = 0.5\text{ A}$ $I_{rr} = 0.25\text{ A}$ $I_R = 1\text{ A}$	$T_j = 25^\circ\text{C}$		12	ns	
		$I_F = 1\text{ A}$ $di_F/dt = -50\text{ A}/\mu\text{s}$ $V_R = 30\text{ V}$					25
I_{RM}	Reverse recovery current	$V_R = 400\text{ V}$ $I_F = 5\text{ A}$ $di_F/dt = -200\text{ A}/\mu\text{s}$	$T_j = 125^\circ\text{C}$		3.8	4.5	A
S	Reverse recovery softness factor				0.4		-

TURN-ON SWITCHING CHARACTERISTICS (for both diodes)

Symbol	Parameter	Tests Conditions	Min.	Typ.	Max.	Unit
t_{fr}	Forward recovery time	$I_F = 5\text{ A}$ $di_F/dt = 100\text{ A}/\mu\text{s}$ $V_{FR} = 1.1 \times V_F\text{ max}$			100	ns
V_{FP}	Transient peak forward recovery voltage	$I_F = 5\text{ A}$ $di_F/dt = 100\text{ A}/\mu\text{s}$			7	V

Fig. 1: Conduction losses versus average current.

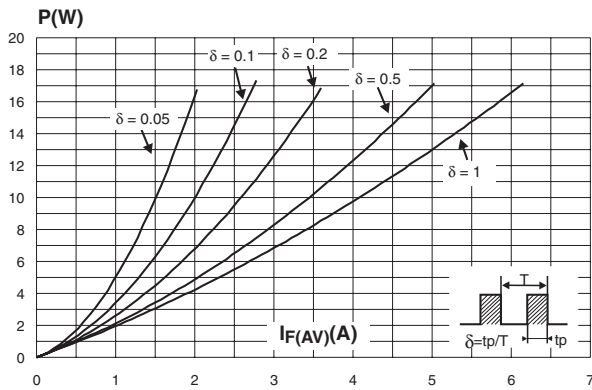

Fig. 2: Forward voltage drop versus forward current.

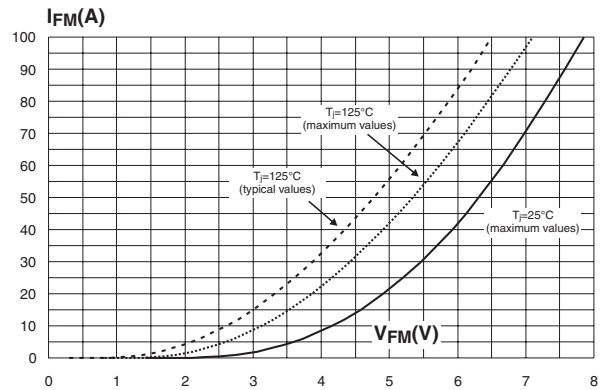

Fig. 3: Relative variation of thermal impedance junction to case versus pulse duration.

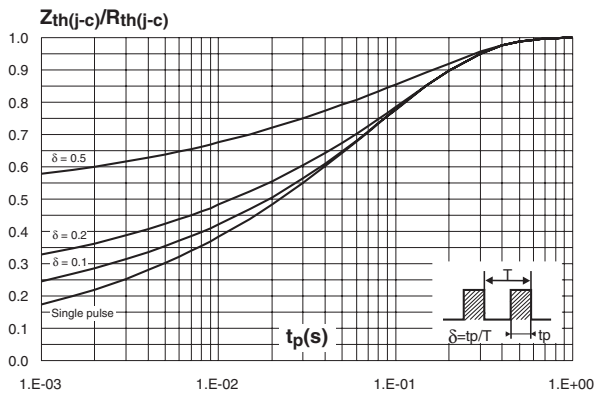

Fig. 4: Peak reverse recovery current versus di_F/dt (90% confidence).

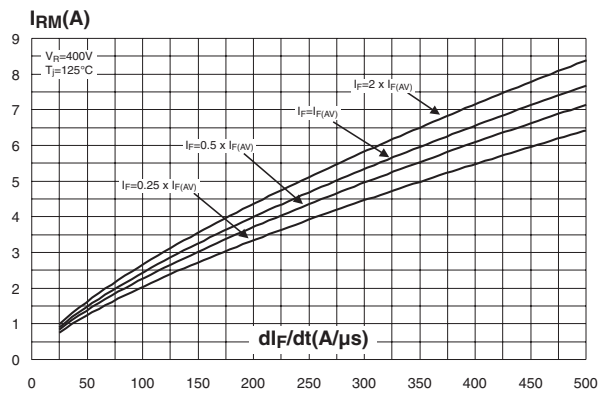

Fig. 5: Reverse recovery time versus di_F/dt (90% confidence).

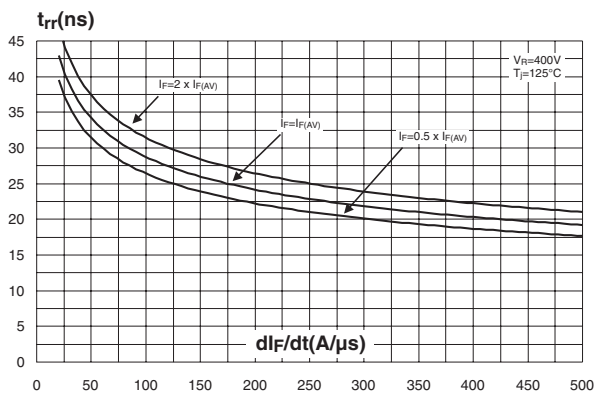

Fig. 6: Reverse recovery charges versus di_F/dt (90% confidence).

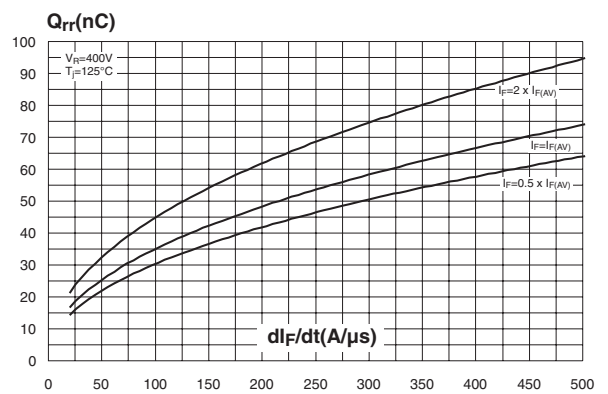

Fig. 7: Reverse recovery softness factor versus di_F/dt (typical values).

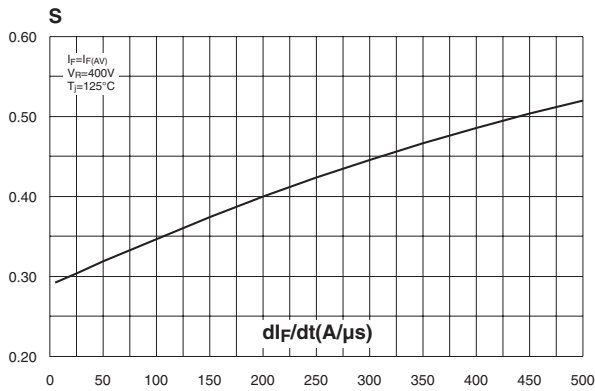

Fig. 8: Relative variation of dynamic parameters versus junction temperature (reference: $T_J = 125^\circ C$).

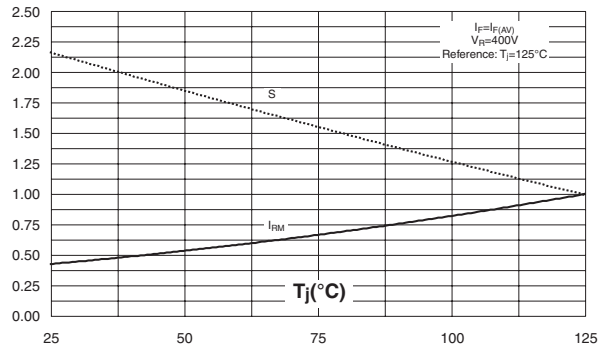

Fig. 9: Transient peak forward voltage versus di_F/dt (90% confidence).

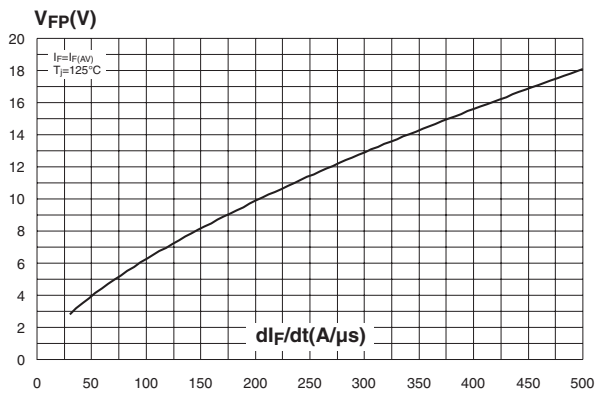

Fig. 10: Forward recovery time versus di_F/dt (90% confidence).

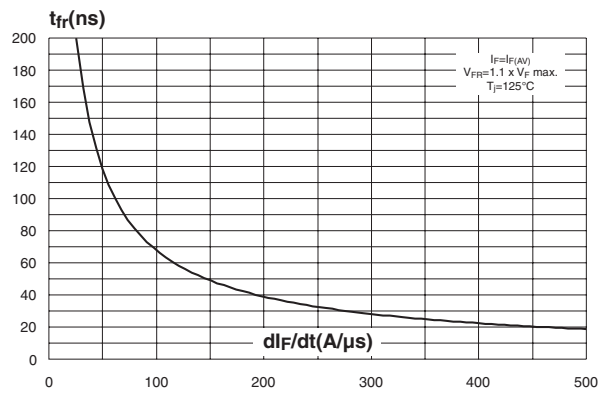
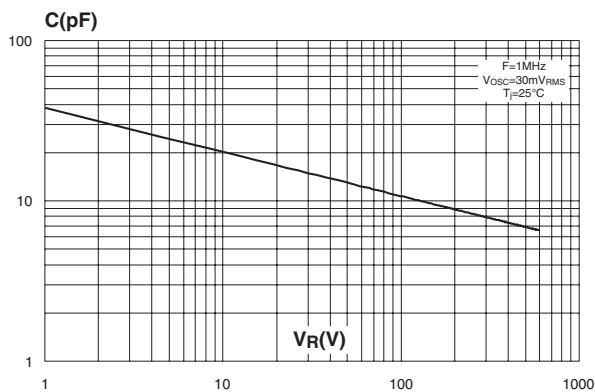
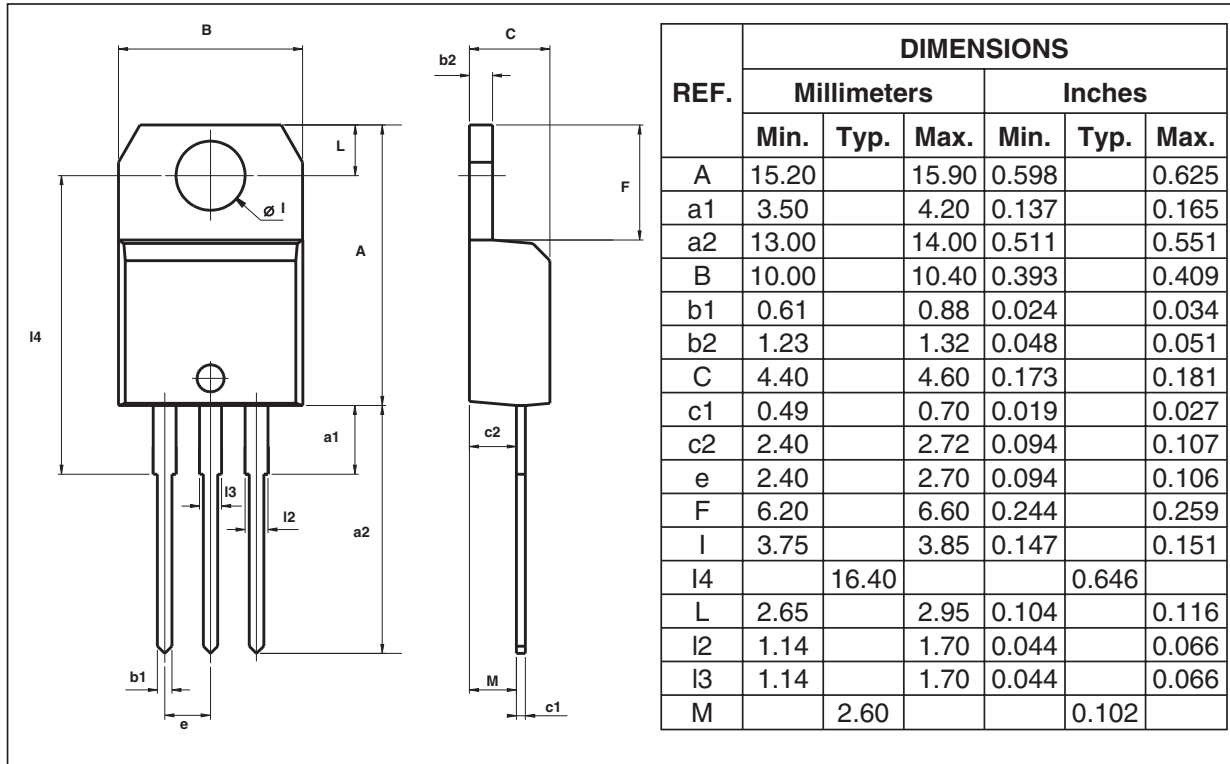

Fig. 11: Junction capacitance versus reverse voltage applied (typical values).



PACKAGE MECHANICAL DATA
TO-220AB

Ordering code	Marking	Package	Weight	Base qty	Delivery mode
STTH506TTI	STTH506TTI	TO-220AB	2.3 g.	50	Tube

- Cooling method: C
- Recommended torque value: 0.8 N.m.
- Maximum torque value: 1 N.m.
- Epoxy meets UL94,V0

Information furnished is believed to be accurate and reliable. However, STMicroelectronics assumes no responsibility for the consequences of use of such information nor for any infringement of patents or other rights of third parties which may result from its use. No license is granted by implication or otherwise under any patent or patent rights of STMicroelectronics. Specifications mentioned in this publication are subject to change without notice. This publication supersedes and replaces all information previously supplied. STMicroelectronics products are not authorized for use as critical components in life support devices or systems without express written approval of STMicroelectronics.

The ST logo is a registered trademark of STMicroelectronics
 © 2003 STMicroelectronics - Printed in Italy - All rights reserved.
 STMicroelectronics GROUP OF COMPANIES
 Australia - Brazil - Canada - China - Finland - France - Germany
 Hong Kong - India - Israel - Italy - Japan - Malaysia - Malta - Morocco - Singapore
 Spain - Sweden - Switzerland - United Kingdom - United States.

<http://www.st.com>

